



Model	RGS22Y
KW	22
Voltage	120/240
Frequency	60HZ



RATING

Voltage	Emergency	PF	KVA	KWE Prime	KVA	Amp Emergency
120/240	24	1	24	22	22	100

Standard features

- Pure, reliable emergency power source
- Legendary Yanmar prime power reliability
- Built with Stamford best-in class alternator
- 100% Block-load capable
- Built to CSA standard with CSA components
- 12V Glow plugs
- Mechanical fuel injection
- Smartgen 6A battery charger
- Standard 120 V 1500W engine circulation heater
- Quick oil & coolant drain system
- 100 litres (17H @ 75%) fuel tank
- Low fuel level alarm,
- LED service light in the engine compartment
- Emission Compliance: Tier 3 Stationary Emergency

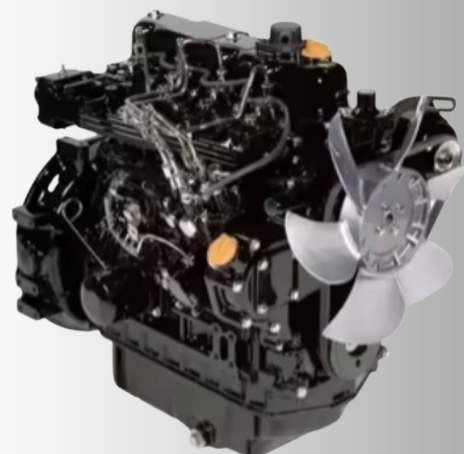

POWERED by
YANMAR™



Model	RGS22Y
KW	22
Voltage	120/240
Frequency	60HZ

Engine specification

Make	Yanmar
Model	4TNV84T-BGGES
Cylinder	4
Displacement	1995cc
Bore & Stroke	84 X 90mm
Compression	18.9 @ 1
Aspiration	Turbo
Injection type	Direct
Speed	1800 RPM
Emergency power	26,8 (KW)
Regulation	5,00%
Governor	Mechanical

Fuel consumption

Fuel tank 100 litre	<u>(Emergency)</u>
Consumption at 25%	1,9 L/H
Consumption at 50%	3,8 L/H
Consumption at 75%	5,7 L/H
Consumption at 100%	7,6 L/H

Sound Level full load

1 meter	67 DB
7 meters	62 DB

Alternator

Manufacturer	Stamford
Model	SOL2-U1
Insulation	Class H
Protection	IP23
Over speed (max 2 min)	2250 TPM
Distortion	< 5%
Bearing Qt	1
Winding	4 Fils

Warranty

Yanmar Engine	<u>24 months / 2000 H</u>
Stamford (standby)	36 months
Generator	12 months / 1500H

Cooling

Capacity	10L
Coolant type	Yanmar LL
Fan power	0,4 KW
Radiator cap pressure	13 PSI

Option

<input type="checkbox"/>	Automatic transfer switch
<input type="checkbox"/>	External fuel tank connection
<input type="checkbox"/>	Choice of colors

Controler

Manufacturer	Deep Sea
Model	DSE4620-06
Starting	Auto / Manual
Exercise mode	Yes programmable

Air intake

Max restriction	2,9 kPa
-----------------	---------

Lubrication

Oil capacity	7,4 Litre
Oil shut down	7 psi
Normal oil pressure	35 psi
Oil change	250 Hours

Weight & dimension

Length	2000 mm
Width	850 mm
Height	1190 mm
Weight	940 kg

Exhaust

Exhaust flow	N/D
Exhaust temp	N/D
Max restriction	1.42 PSI





Model	RGS22Y
KW	22
Voltage	120/240
Frequency	60HZ

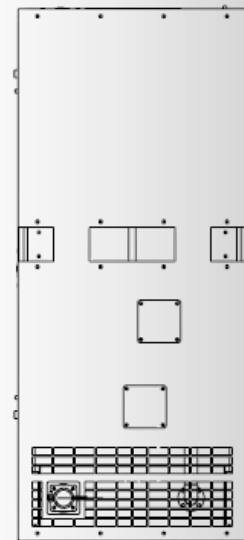
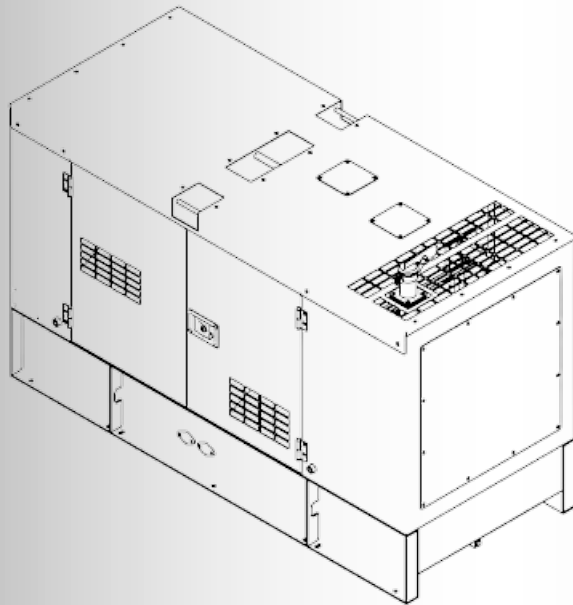
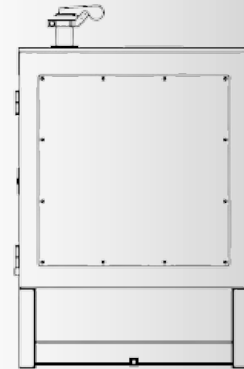
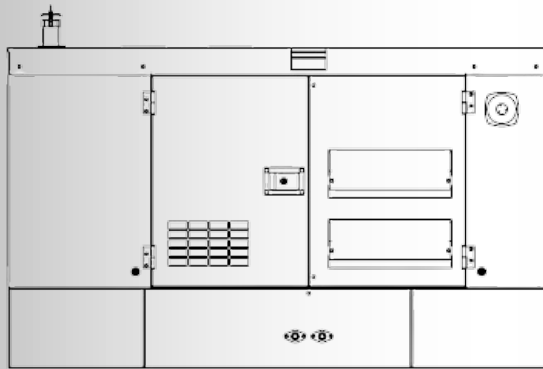
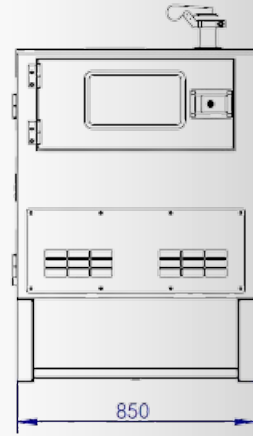
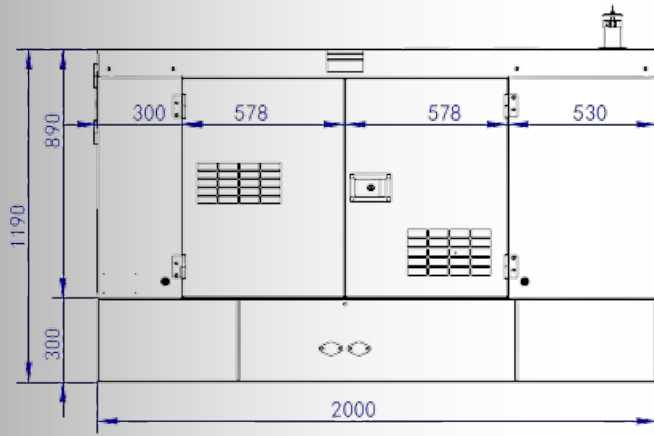

STAMFORD | AvK™